

This manual corresponds to the following references:

PHSE-1KB (120V)

PHSE-2KB (230V)

PHSE-9KB (100V)

Packing List

The following items are included:



Small Preheater Unit 1 unit

Small PCB Support 1 unit
Ref. PHS-SA



Console 1 unit
Ref. ACE-A

RJ45 Cable 1 unit
Ref. 0019914

Power Cord1 unit
Ref. 0023715 (120V)
0023714 (230V)
0024092 (100V)



Kapton Tape 1 unit
Ref. PH217

Thermocouple 2 unit
Ref. PH218

Manual 1 unit
Ref. 0026747

Features and Connections

Heater Unit

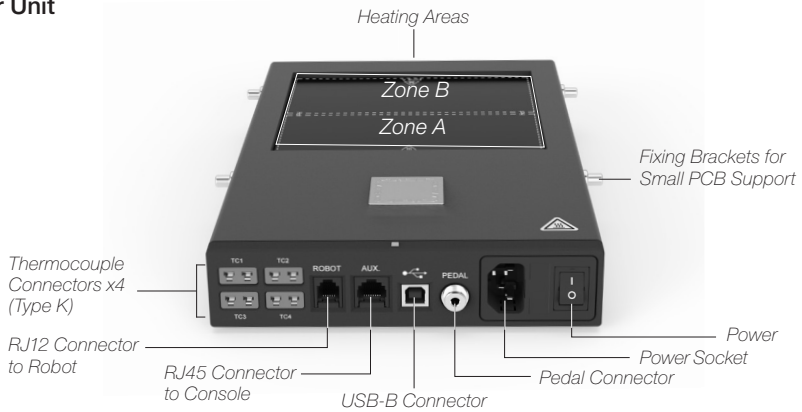

Console

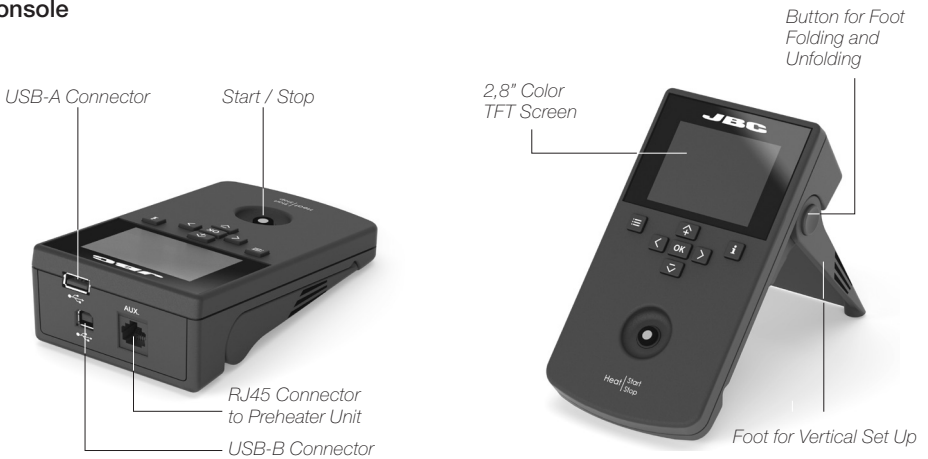

Support

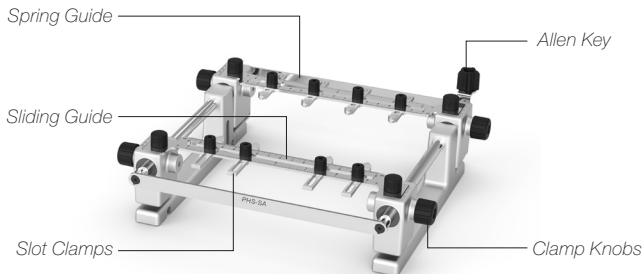

Height Adjustment

It allows adjustment for **3 heights** between the PCB and the Heating Area of the Preheater.

Low level
28mm

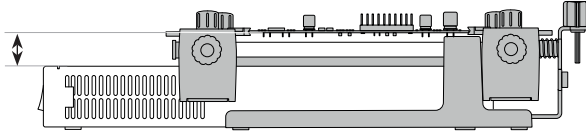

Unscrew these knobs to place the support in the lowest level



Medium level
50mm

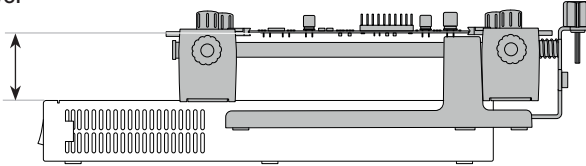

Use the fixing brackets to place the support in the medium and the high level



High level
70mm

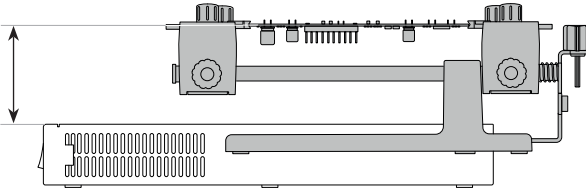

To change the height to the highest level, proceed as follows:

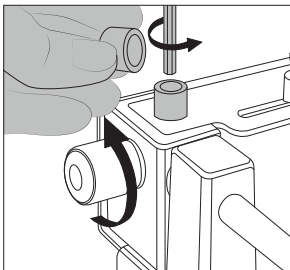

1. Remove the 4 clamp knobs and the 4 black rubber caps.

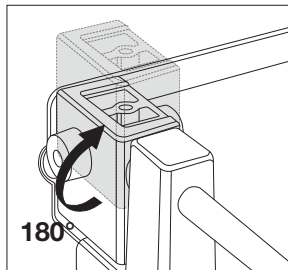

2. After removing both guides, turn 180° the guide supports.

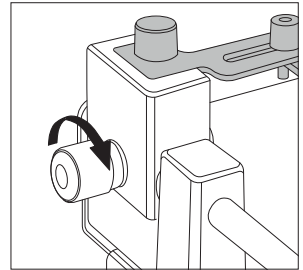

3. Place the guides, the rubber cups and adjust the sliding clamp knobs again.

Fast PCB Replacement

The support lets you replace PCBs of the same batch fast and easily. Use the sliding guides to change the PCBs.

Removing the PCB

Loosen one sliding guide, push the PCB against the sliding guide and lift out.

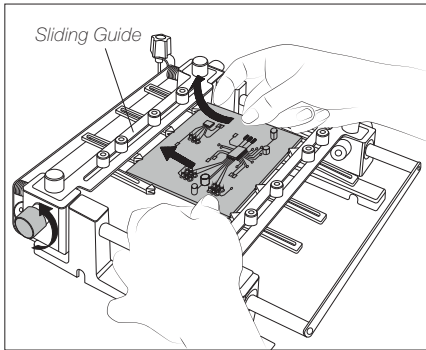

Placing another PCB

Position it and tighten the sliding guide knobs.

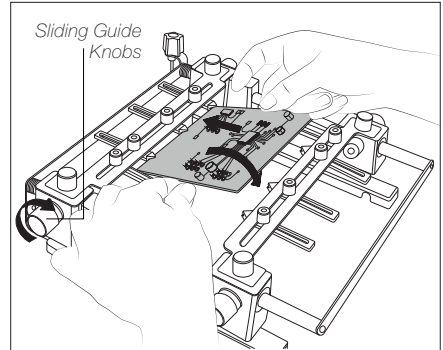

Reworking large PCBs

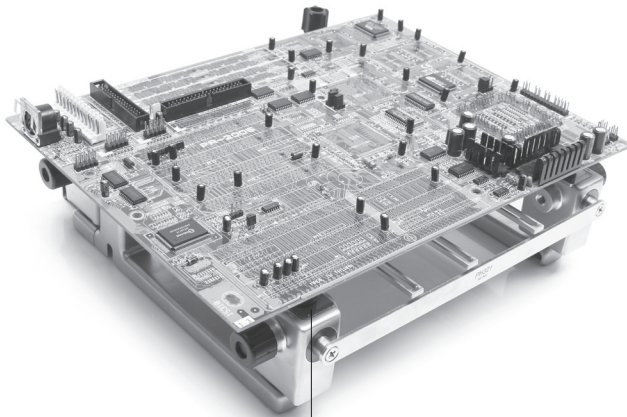

Adjustable slot clamps for switching PCBs

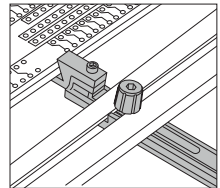

Place large PCBs on the 4 rubber caps

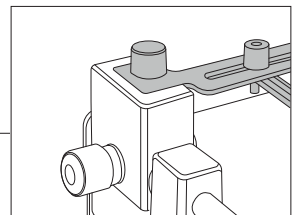

Work Screen

The Console offers an intuitive user interface which provides quick access to station parameters.

Status Bar — Speaker icon, 14:15

Instant Power Supplied to Heater — Vertical bar, 45%

Thermocouple Current Temp. — TC1: 45°C, Selected 120°C

Thermocouple Selected Temp. and Mode — TC2: 20°C, TC3: 20°C, TC4: 20°C

Control [C] **Protection** [P] **Info** [i]

Menu Options — List icon, Home icon, Info icon, Directional pad (Up, Down, Left, Right, OK)

Station Information — Info icon

***Original PIN: 0105**



General



Work mode



Profile editor



Graphics



Files









Reset

Available languages: English, Spanish, German, French, Italian, Portuguese, Japanese, Chinese, Russian and Korean.

Troubleshooting

Station troubleshooting available on the product page at www.jbctools.com

System notifications (Status Bar)

-  USB flash drive is connected.
-  Station is controlled by a PC.
-  Station is controlled by a robot.
-  Station software update.
Press INFO to start the process.
-  Warning.
Press INFO for failure description.
-  Error. Press INFO for failure description, the type of error and how to proceed.

Setting Thermocouples Function

Select *Thermocouples* from the *Work mode* menu to set them up.

The thermocouples (TC) can work in three different ways depending on what is needed.

- C** · Control: the unit maintains the selected temperature.
- P** · Protection: the Heater Unit stops if the TC reaches the selected temperature.
 - Info: the TC temperature is shown in the work screen.

The TC1 is always working in Control mode for the *Temperature* mode as well as for *Profiles* mode. The temperature of each TC can also be selected from the work screen.

Recommended Guidelines

1. Place the Control Thermocouple as near as possible to the component being worked on.
2. If there are any sensitive components, use a Thermocouple as protection.
You can select the protection temperature in the *Thermocouples* menu. If the selected temperature is reached, the Heater Unit will stop the process and a warning message will be shown.

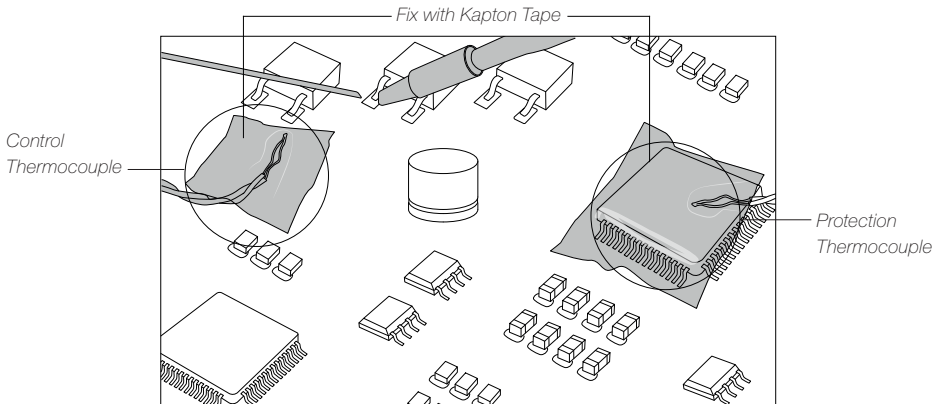

3. IPC* does not recommend exceeding ramp-up rates over 3 - 4 °C / sec (5 - 7 °F / sec) so as to reduce the risk of thermal stress on the PCB.

* IPC was founded in the U.S. in 1957 as the Institute for Printed Circuits and is committed to becoming the most recognized international industry association for the electronics manufacturing industry.

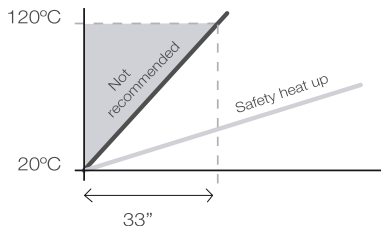

Work Mode

Temperature Mode

Select *Temp. mode* from the *Work mode* menu. In this mode the heater unit maintains the selected temperature for the TC1 thermocouple as long as the other TC's do not reach the control/protection temperature limit.

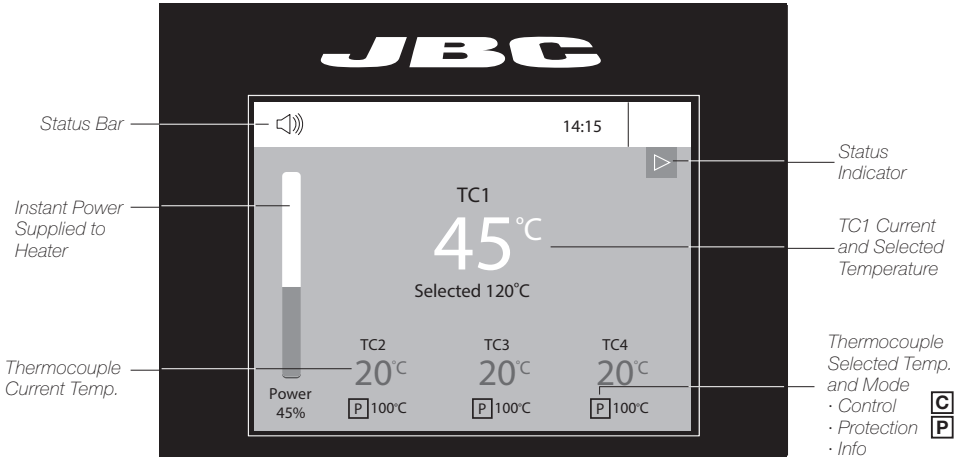

Power Mode

Select *Power mode* from the *Work mode* menu. In this mode the heater unit maintains the selected power as long as the thermocouples do not reach the control/protection temperature limit.

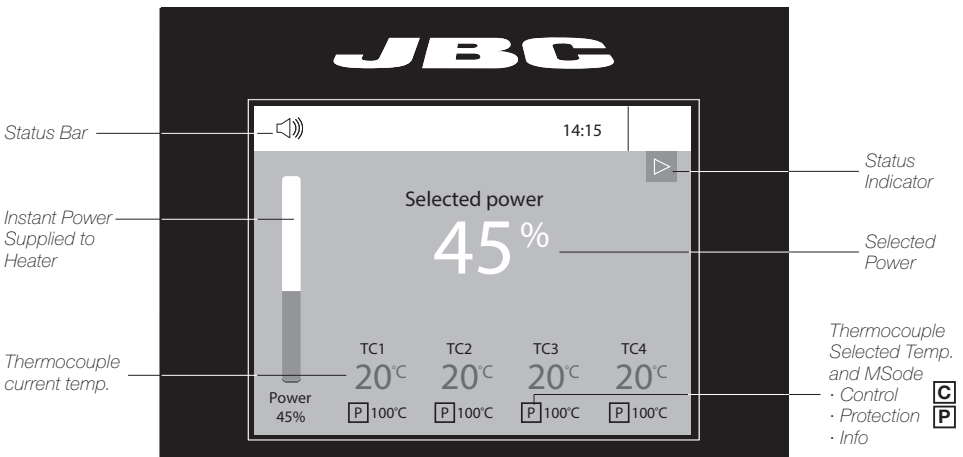

Profile Modes

Select *Profile Mode* from the *Work Mode* Menu. In this mode the heater unit regulates the temperature of the TC1 thermocouple according to the selected profile as long as the other TCs do not reach the control/protection temperature limit.

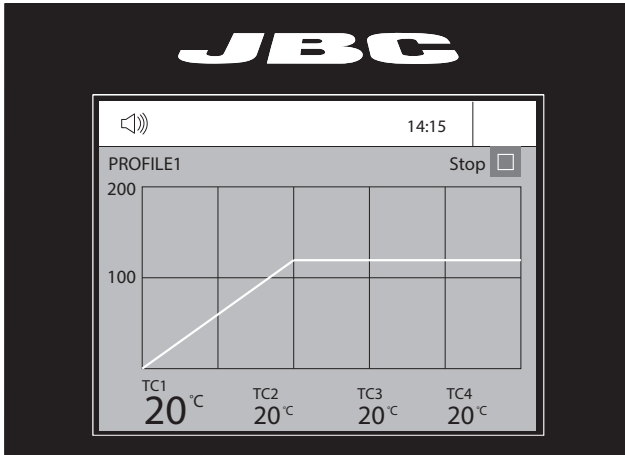

Teach Profile

For repetitive jobs **you** running profiles without the Thermocouple (TC). In order to do so, the *Teach profile* mode has to be executed before running any profile. It can be executed from the *Work mode* menu if the *Profiles* mode is selected. Once the profile has been run to the end, the system has all the process data which you can save.

Once it is saved, you can run this profile without connecting the Thermocouple (TC). The heating process will be the same as long as the same working conditions are respected.

The profiles which already have the data from the *Teach profile* are marked with this symbol

These profiles can be run either with or without the Thermocouples. It can be chosen from the *Profiles* mode work screen:



Profile Editor



Profile Editor

The *Profile editor* can be opened from the main menu or from the *Profiles* mode work screen by pressing the 'OK' button.

In this mode you can **edit** as many as 25 profiles of temperature.

Profile Name → PROFILE1 5m 00s

Data for these Points →

Point	Temp	Time
2/3	120°C	2m 00s

Menu Options

- Add Point
- Delete Point
- Load Profile
- Save Profile
- Exit

JBC Set Profiles

There are 3 profiles predefined by JBC: A, B and C. The difference between them is the number of steps: 2, 3 or 4. The thicker your PCB is and the more layers it contains, the more steps are needed to obtain a gradual warming.

These profiles are not modifiable but can be used as a template to create your own profiles.

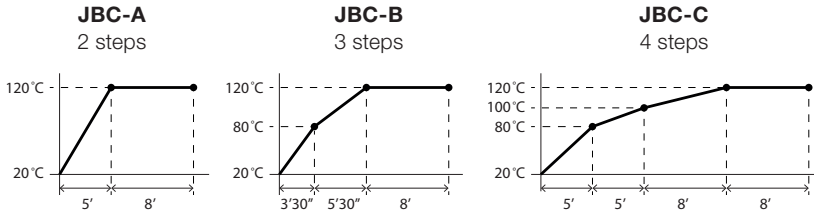

PCB Reference Specifications: FR4 1,6mm thick and 2 layers.

FR4 1,6mm thick and 6 layers.

FR4 2,2mm thick and 6 layers.

Profiles set using the low position of the PHS-SA Support (28 mm in height between the PCB and the heating area).

Process Analysis



Graphics

By pressing **Graphics** in the main MENU, temperature of TC1 thermocouple and power figures in real time are displayed.

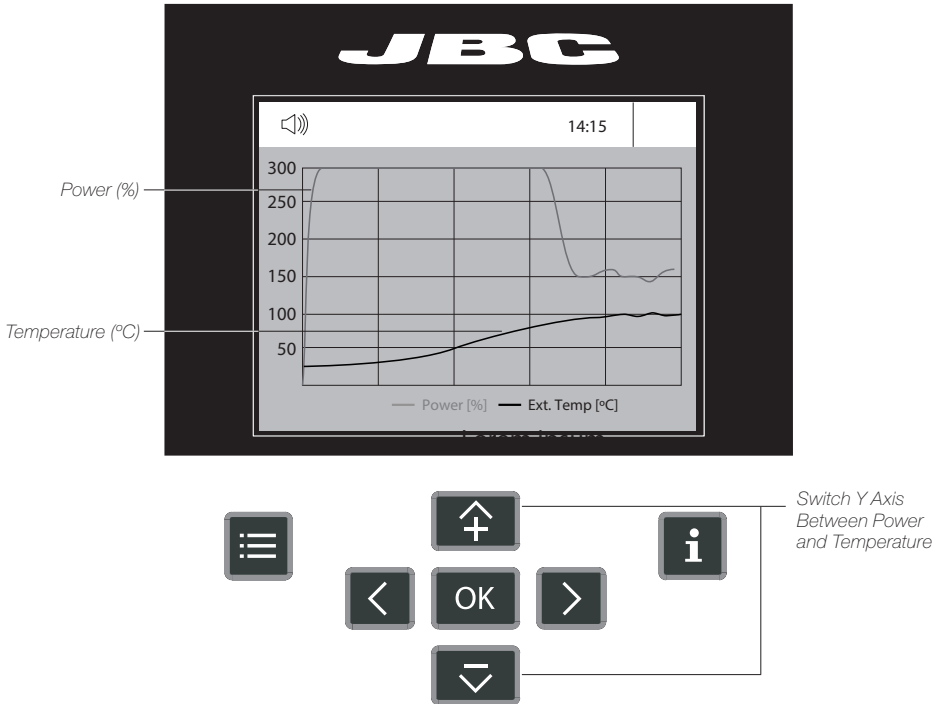

System Notifications

The following icons will be displayed on the screen's status bar.

 USB flash drive is connected.

 Station software update.
Press INFO to start the process.

 Station is controlled by a PC.

 Warning.
Press INFO for failure description.

 Station is controlled by a robot.

 Error.
Press INFO for failure description, the type of error and how to proceed.

Files



Files

Export Graphics

Insert a USB flash drive into the USB-A connector to save your soldering process in csv format.

Export / Import Profiles

Insert a USB flash drive into the USB-A connector to export / import profiles.

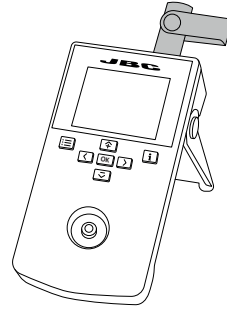

Update the Station Software

1. Download the JBC Update File from www.jbctools.com/software.html and save it on a USB flash drive. (Preferably one with no other files).

2. Insert the USB flash drive to the console. The icon  is displayed while updating.

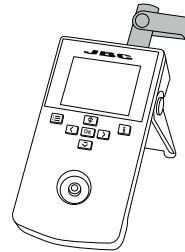
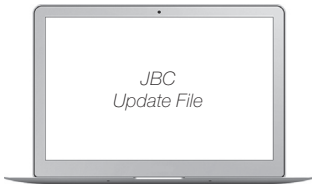

Working with Pedal

Press the pedal to start heating and press again to stop as if it was the button on the console. Once the Work Mode is set, the Heater Unit can work without the console using the pedal.



Maintenance

Before carrying out maintenance or storage, always allow the equipment and the support to cool down.

- Check periodically that the Pre Heater is clean.
- Use a damp cloth when cleaning. Alcohol can only be used to clean the metal parts.
- Only if it is absolutely necessary and if cleaning with isopropyl alcohol (IPA) is not enough, it is recommended to use a scraper to remove dirt in the glass area.
- Replace any defective or damaged parts. Use original JBC spare parts only.
- Repairs should only be performed by a JBC authorized technical service.

Safety



It is imperative to follow safety guidelines to prevent electric shock, injury, fire or explosion.

- Do not use the units for any purpose other than PCB preheating. Incorrect use may cause fire.
- The mains cable must be plugged into approved bases. Make sure that it is properly grounded before use. When unplugging it, hold the plug, not the wire.
- The temperature of accessible surfaces may remain high after the unit is turned off. Handle with care.
- Do not leave the appliance unattended when it is on.
- Do not cover the ventilation grills. Heat can cause inflammable products to ignite.
- Heat can cause inflammable products to ignite even when out of sight.
- Be careful with the remains of liquid tin. In contact with skin, it can cause burns.
- Avoid flux coming into contact with skin or eyes to prevent irritation.
- Be careful with the smoke produced when soldering.
- Keep your workplace clean and tidy. Wear appropriate protection glasses and gloves when working to avoid personal harm.
- This appliance can be used by children over the age of eight as well as persons with reduced physical, sensory or mental capabilities or lacking experience provided that they have been given adequate supervision or instruction concerning use of the appliance and understand the hazards involved. Children must not play with the appliance.
- Maintenance must not be carried out by children unless supervised.

Specifications

Small Preheater Set

PHSE-1KB 120V. Input 120V 50/60Hz Fuse T8A

PHSE-2KB 230V. Input 230V 50/60Hz Fuse T4A

PHSE-9KB 100V. Input 100V 50/60Hz Fuse T8A

Small Preheater Unit

- Maximum Power: 600W
- Heating Area: 65 x 135 mm / 2.56 x 5.31 in - 1 zone
130 x 135 mm / 5.12 x 5.31 in - 2 zones
- Ambient Operating Temperature: 10 - 40 °C / 50 - 104 °F
- Temperature Range: 50 - 250 °C / 120 - 482 °F
- Temperature Measurement: Thermocouple type K
- JBC Set Temperature Profiles: 3 profiles (2, 3 or 4 steps)
- User Profiles: 20 (up to 6 steps for each)
- Maximum Work Time: 600 min or indefinite
- Dimensions / Weight: 195 x 288 x 41.5 mm / 1.74 kg
(L x W x H) 7.68 x 11.34 x 1.63 in / 3.84 lb

Small PCB Support (PHS-SA)

- Weight: 2 kg / 4.4 lb
- Dimensions (Low Position): 267 x 259 x 75 mm
(L x W x H) 10.5 x 10.2 x 3 in
- Dimensions (High Position): 267 x 259 x 96 mm
(L x W x H) 10.5 x 10.2 x 3.8 in
- Max. PCB Dimension (Low Position): 180 x 175 mm / 7.09 x 6.89 in

Small Preheater Set

- Total Net Weight: 4.8 kg / 10.6 lb
- Total Package Dimensions / Weight: 368 x 368 x 195 mm / 5.8 kg
(L x W x H) 14.5 x 14.5 x 7.7 in / 12.8 lb

Complies with CE standards.
ESD protected housing.

JBC

Warranty

JBC's 2 year warranty covers this equipment against all manufacturing defects, including the replacement of defective parts and labour.

Warranty does not cover product wear or misuse.

In order for the warranty to be valid, equipment must be returned, postage paid, to the dealer where it was purchased.

Get 1 extra year JBC warranty by registering here:
<https://www.jbctools.com/productregistration/>
within 30 days of purchase.



This product should not be thrown in the garbage.

In accordance with the European directive 2012/19/EU, electronic equipment at the end of its life must be collected and returned to an authorized recycling facility.



www.jbctools.com